

ISOMETRIC VIEW

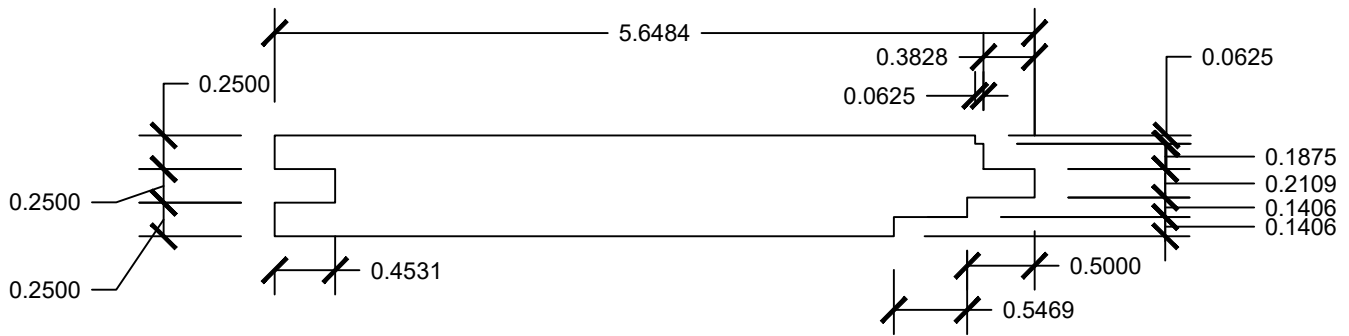

SIDE SECTION

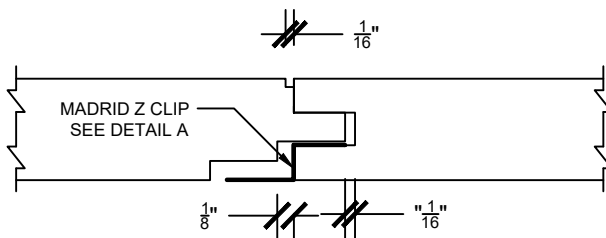

CONNECTION VIEW

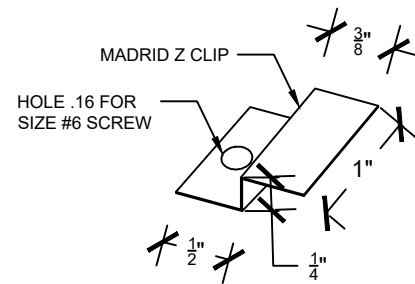

DETAIL A



MADRID
 7800 INDUSTRY AVENUE
 PICO RIVERA, CA 90660
 WWW.MADRIDINC.COM

DRAWING TITLE:

STANDARD MADRID TONGUE & GROVE PANEL

NO GROVE PANEL

DWG. NO.

1 OF 1

THIS DOCUMENT CONTAINS CONFIDENTIAL AND PROPRIETARY INFORMATION. ALL RECIPIENTS OF THIS DOCUMENT ARE TO PROTECT THE OWNERS DATA FROM USE BY OR TRANSFER TO NON AUTHORIZED PARTIES BY LEGAL MEANS POSSIBLE COPYRIGHT © 2013 CAD DESIGN AND DRAFTING

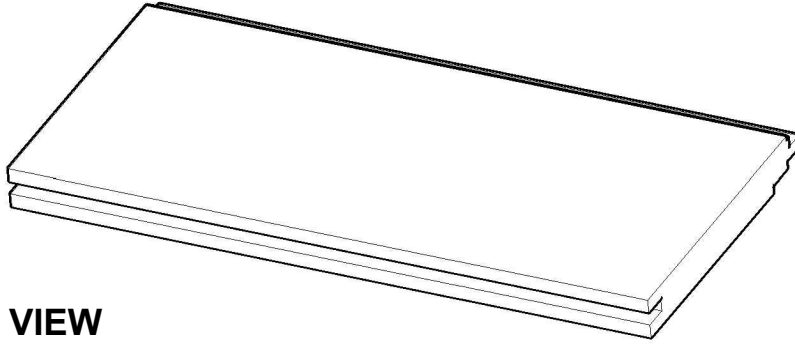

ISOMETRIC VIEW

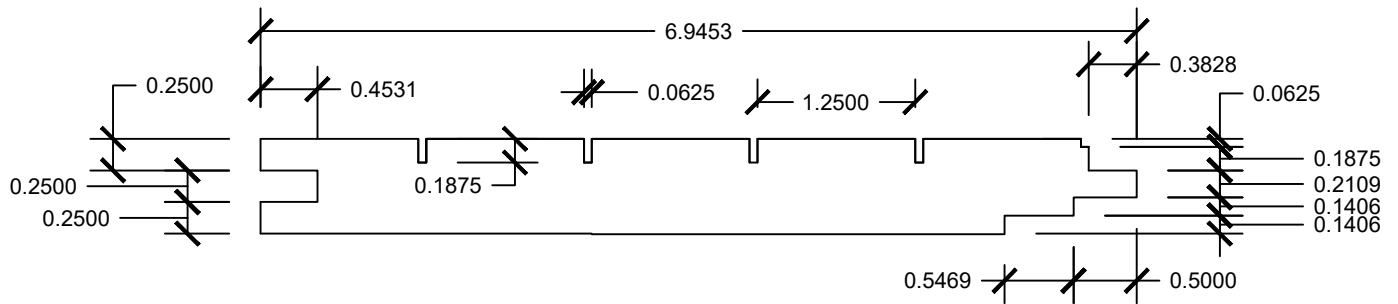

SIDE SECTION

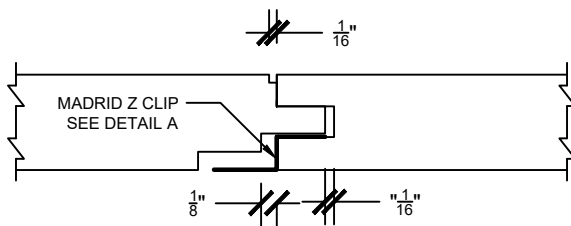

CONNECTION VIEW

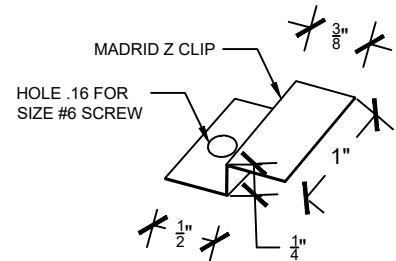

DETAIL A



MADRID
 7800 INDUSTRY AVENUE
 PICO RIVERA, CA 90660
 WWW.MADRIDINC.COM

DRAWING TITLE:

STANDARD MADRID PANEL TONGUE & GROVE

1-1/4" SPACING PANEL

DWG. NO.

1 OF 1

THIS DOCUMENT CONTAINS CONFIDENTIAL AND PROPRIETARY INFORMATION. ALL RECIPIENTS OF THIS DOCUMENT ARE TO PROTECT THE OWNERS DATA FROM USE BY OR TRANSFER TO NON AUTHORIZED PARTIES BY LEGAL MEANS POSSIBLE COPYRIGHT © 2013 CAD DESIGN AND DRAFTING

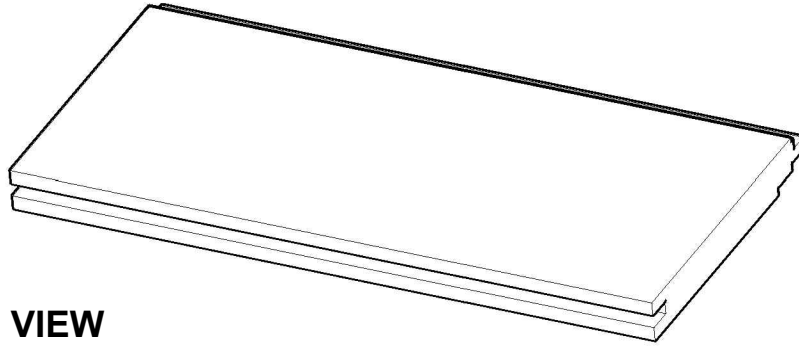

ISOMETRIC VIEW

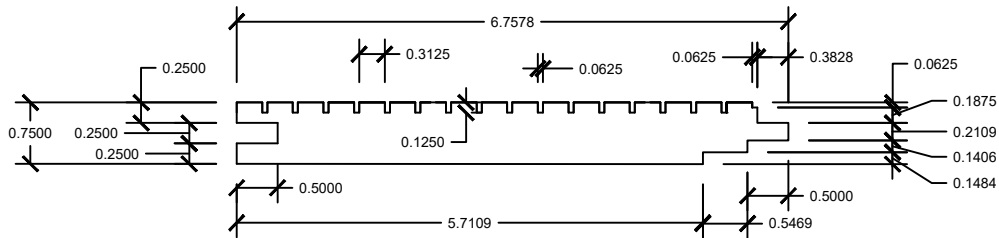

SIDE SECTION

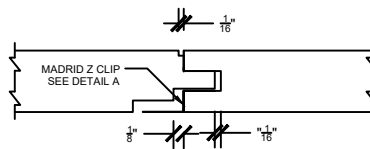

CONNECTION VIEW



MADRID
 7800 INDUSTRY AVENUE
 PICO RIVERA, CA 90660
 WWW.MADRIDINC.COM

DRAWING TITLE:

STANDARD MADRID PANEL TONGUE & GROVE

1/16" SPACING GROVES

DWG. NO.

1 OF 1

THIS DOCUMENT CONTAINS CONFIDENTIAL AND PROPRIETARY INFORMATION. ALL RECIPIENTS OF THIS DOCUMENT ARE TO PROTECT THE OWNERS DATA FROM USE BY OR TRANSFER TO NON AUTHORIZED PARTIES BY LEGAL MEANS POSSIBLE COPYRIGHT © 2013 CAD DESIGN AND DRAFTING

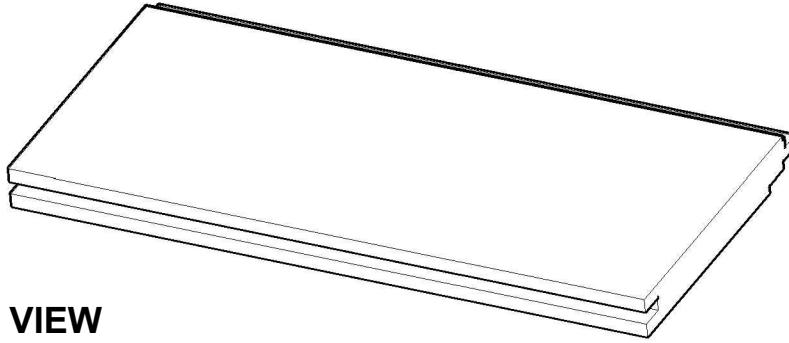

ISOMETRIC VIEW

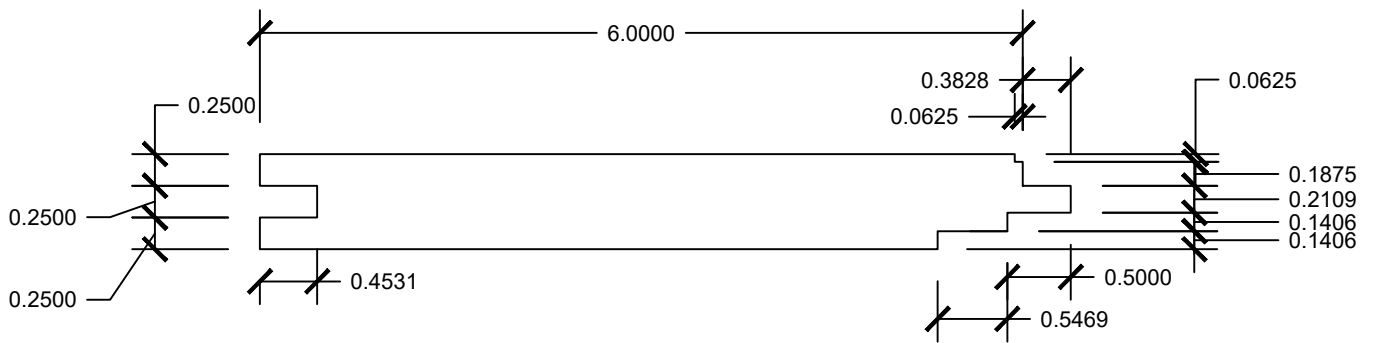

SIDE SECTION

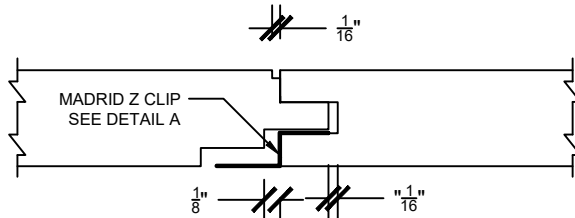

CONNECTION VIEW

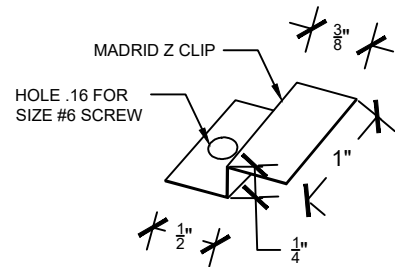

DETAIL A



MADRID
 7800 INDUSTRY AVENUE
 PICO RIVERA, CA 90660
 WWW.MADRIDINC.COM

DRAWING TITLE:

STANDARD MADRID TONGUE & GROVE PANEL

NO GROVE PANEL

DWG. NO.

1 OF 1

THIS DOCUMENT CONTAINS CONFIDENTIAL AND PROPRIETARY INFORMATION. ALL RECIPIENTS OF THIS DOCUMENT ARE TO PROTECT THE OWNERS DATA FROM USE BY OR TRANSFER TO NON AUTHORIZED PARTIES BY LEGAL MEANS POSSIBLE COPYRIGHT © 2013 CAD DESIGN AND DRAFTING