

**ISOMETRIC VIEW**

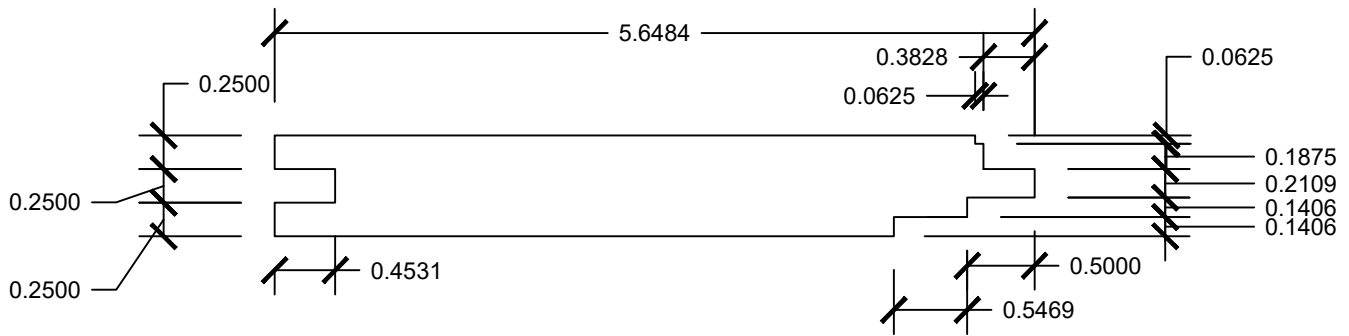

**SIDE SECTION**

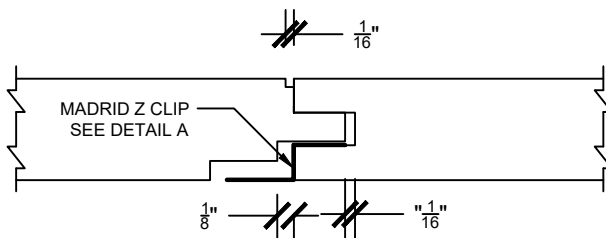

**CONNECTION VIEW**

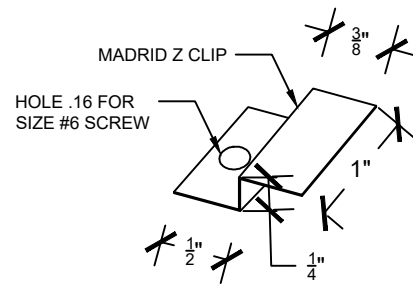

**DETAIL A**



**MADRID**  
 7800 INDUSTRY AVENUE  
 PICO RIVERA, CA 90660  
 WWW.MADRIDINC.COM

DRAWING TITLE:

STANDARD MADRID TONGUE & GROVE PANEL

NO GROVE PANEL

DWG. NO.

1 OF 1

THIS DOCUMENT CONTAINS CONFIDENTIAL AND PROPRIETARY INFORMATION. ALL RECIPIENTS OF THIS DOCUMENT ARE TO PROTECT THE OWNERS DATA FROM USE BY OR TRANSFER TO NON AUTHORIZED PARTIES BY LEGAL MEANS POSSIBLE COPYRIGHT © 2013 CAD DESIGN AND DRAFTING

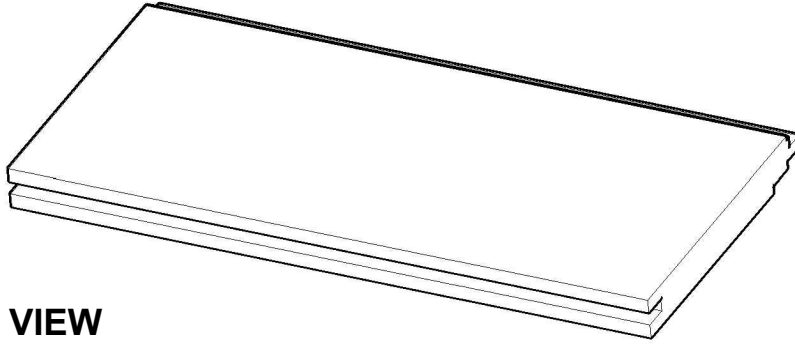

**ISOMETRIC VIEW**

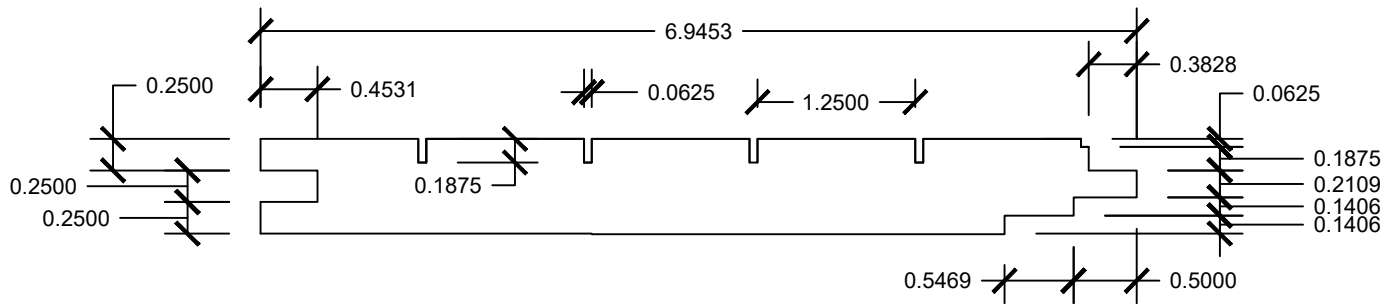

**SIDE SECTION**

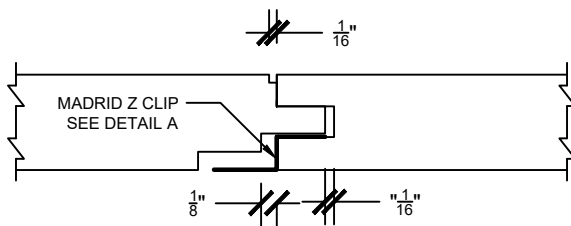

**CONNECTION VIEW**

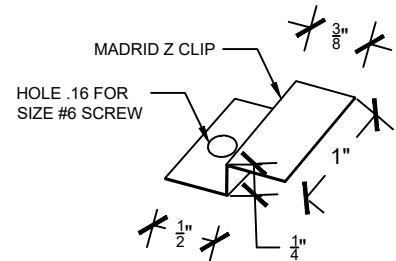

**DETAIL A**



**MADRID**  
 7800 INDUSTRY AVENUE  
 PICO RIVERA, CA 90660  
 WWW.MADRIDINC.COM

DRAWING TITLE:

STANDARD MADRID PANEL TONGUE & GROVE

1-1/4" SPACING PANEL

DWG. NO.

1 OF 1

THIS DOCUMENT CONTAINS CONFIDENTIAL AND PROPRIETARY INFORMATION. ALL RECIPIENTS OF THIS DOCUMENT ARE TO PROTECT THE OWNERS DATA FROM USE BY OR TRANSFER TO NON AUTHORIZED PARTIES BY LEGAL MEANS POSSIBLE COPYRIGHT © 2013 CAD DESIGN AND DRAFTING

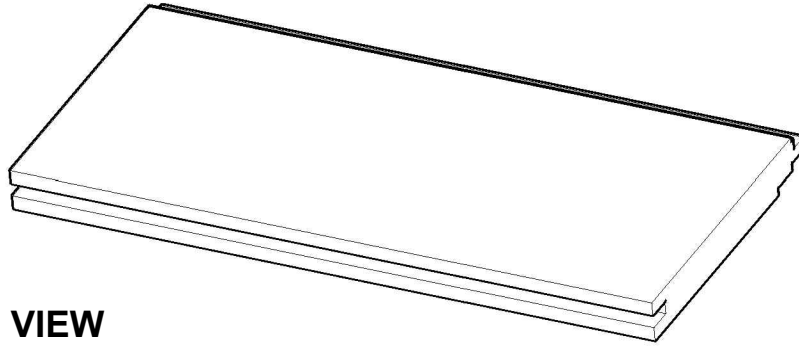

**ISOMETRIC VIEW**

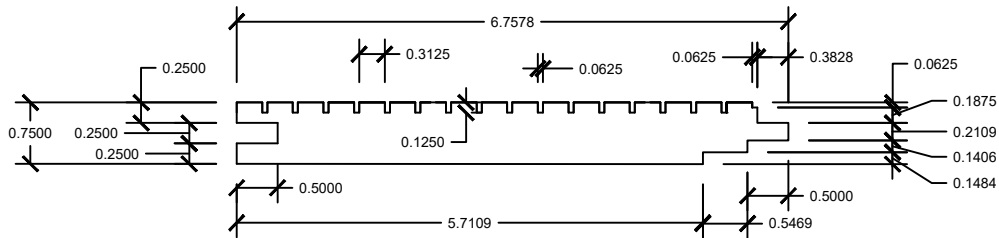

**SIDE SECTION**

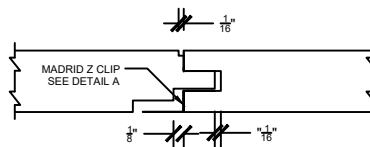

**CONNECTION VIEW**



**MADRID**  
 7800 INDUSTRY AVENUE  
 PICO RIVERA, CA 90660  
 WWW.MADRIDINC.COM

DRAWING TITLE:

STANDARD MADRID PANEL TONGUE & GROVE

1-1/4" SPACING PANEL

DWG. NO.

1 OF 1

THIS DOCUMENT CONTAINS CONFIDENTIAL AND PROPRIETARY INFORMATION. ALL RECIPIENTS OF THIS DOCUMENT ARE TO PROTECT THE OWNERS DATA FROM USE BY OR TRANSFER TO NON AUTHORIZED PARTIES BY LEGAL MEANS POSSIBLE COPYRIGHT © 2013 CAD DESIGN AND DRAFTING

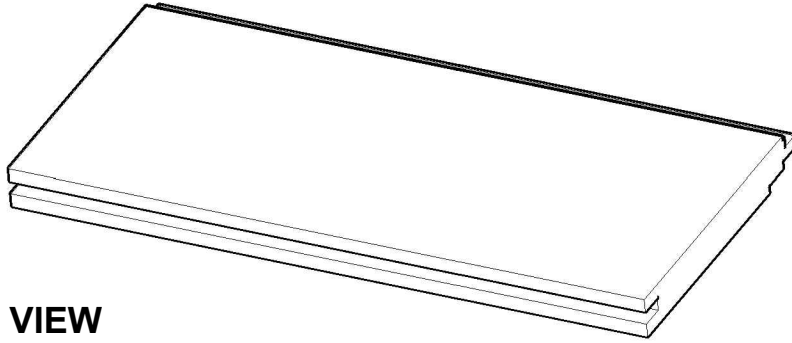

**ISOMETRIC VIEW**

**CLG-5**

MATERIAL: MDF

PL-3 LAMINATE:  
WILSONART  
8213K-28

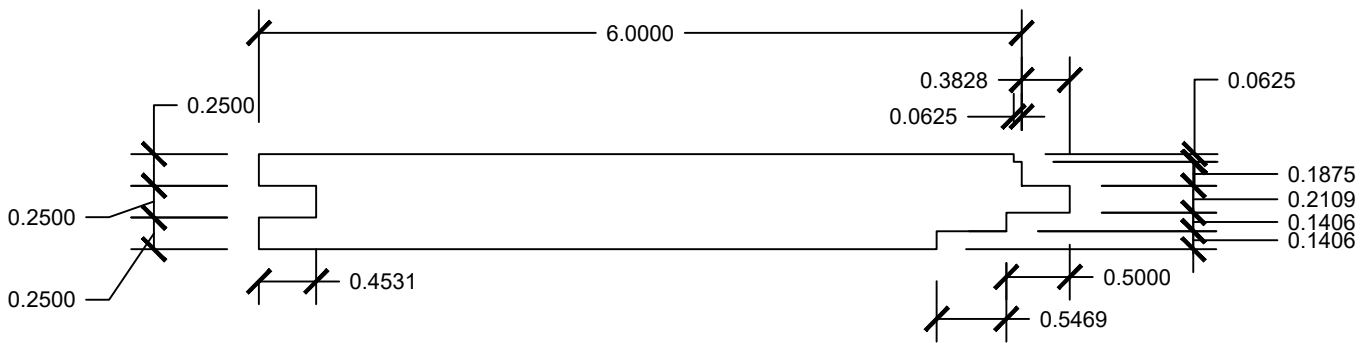

**SIDE SECTION**

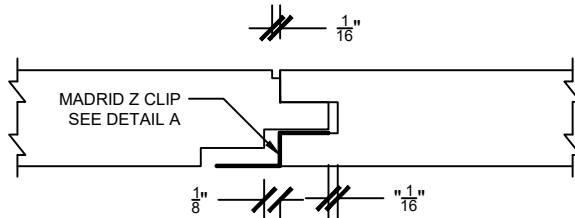

**CONNECTION VIEW**

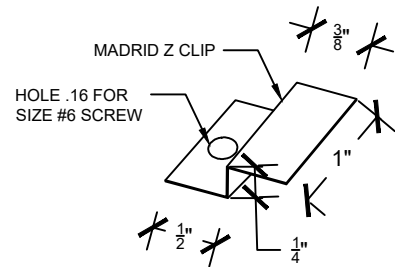

**DETAIL A**



**MADRID**  
7800 INDUSTRY AVENUE  
PICO RIVERA, CA 90660  
WWW.MADRIDINC.COM

DRAWING TITLE:

STANDARD MADRID TONGUE & GROVE PANEL

PROJECT:

LENNAR - TENANT IMPROVEMENT

DWG. NO.

A1

THIS DOCUMENT CONTAINS CONFIDENTIAL AND PROPRIETARY INFORMATION. ALL RECIPIENTS OF THIS DOCUMENT ARE TO PROTECT THE OWNERS DATA FROM USE BY OR TRANSFER TO NON AUTHORIZED PARTIES BY LEGAL MEANS POSSIBLE COPYRIGHT © 2013 CAD DESIGN AND DRAFTING