

PLAN - 5" GRID LOCK

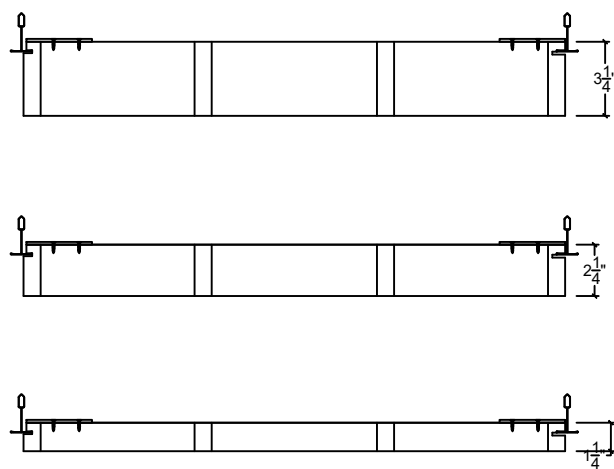

SECTION

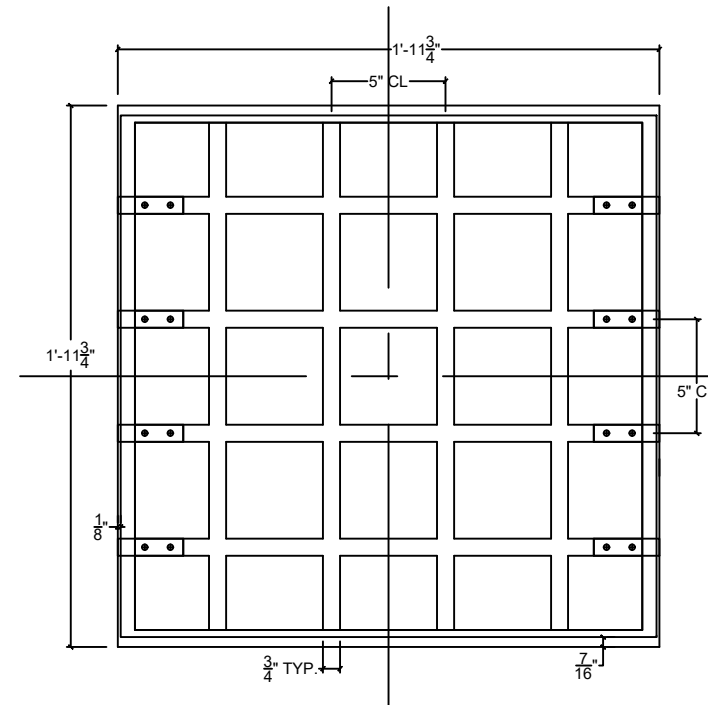

PLAN - 8" GRID LOCK

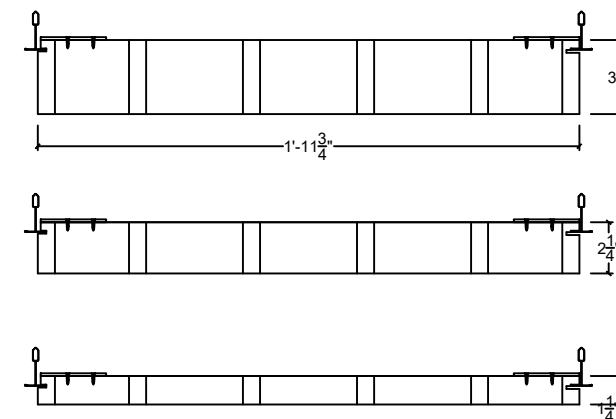

SECTION

10088-47



MADRID

7800 INDUSTRY AVENUE
PICO RIVERA, CA 90660
WWW.MADRIDINC.COM

OPEN CELL

GRID LOCK 5" & 8"

1 OF 4

10088-48

THIS DOCUMENT CONTAINS CONFIDENTIAL AND PROPRIETARY INFORMATION.
ALL RECIPIENTS OF THIS DOCUMENT ARE TO PROTECT THE OWNERS DATA FROM USE BY OR TRANSFER
TO NON AUTHORIZED PARTIES BY LEGAL MEANS POSSIBLE COPYRIGHT © 2013 CAD DESIGN AND DRAFTING

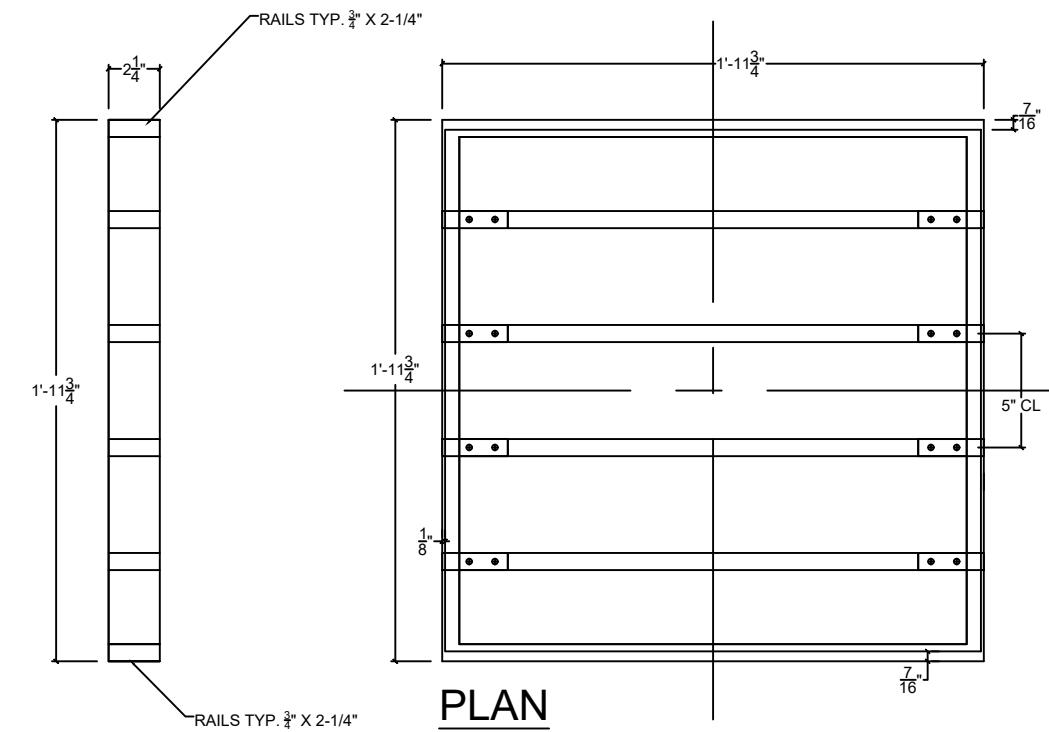

SIDE VIEW

PLAN

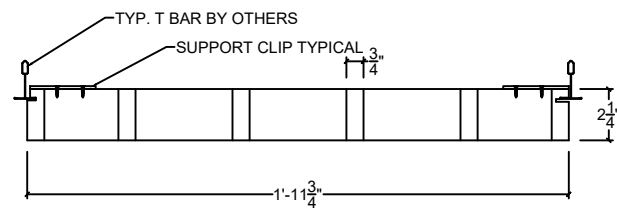

SECTION

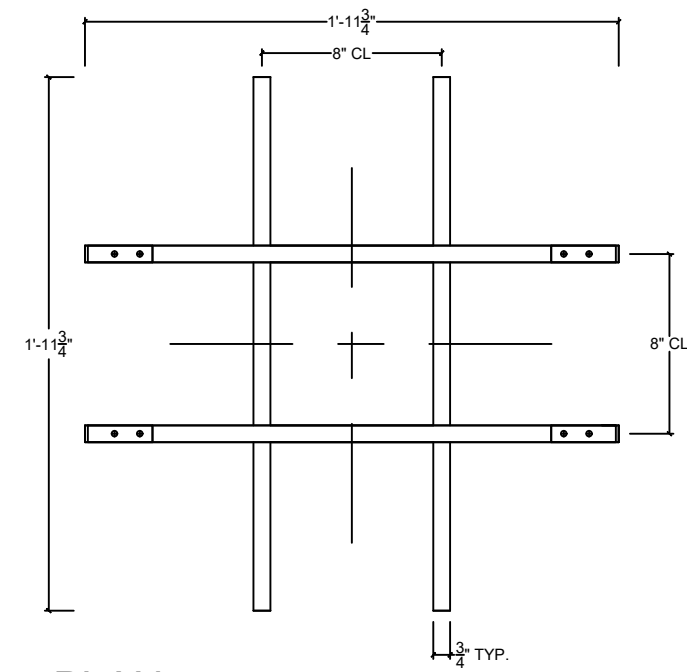

PLAN

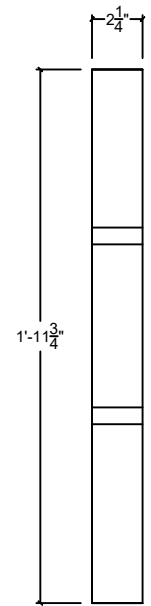

SIDE VIEW

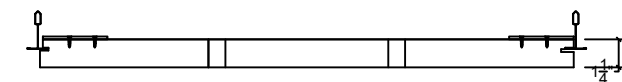
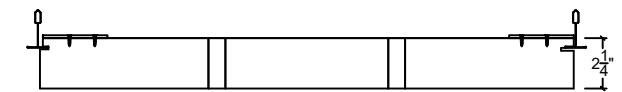
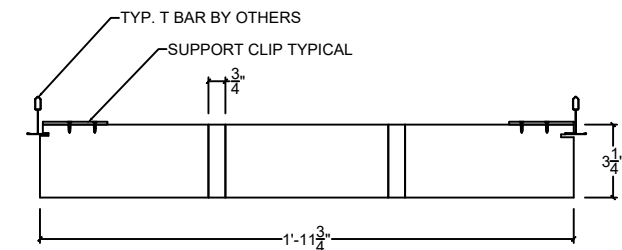

SECTION

10088-50



MADRID

7800 INDUSTRY AVENUE
PICO RIVERA, CA 90660
WWW.MADRIDINC.COM

OPEN CELL

GRID LOCK 5"

2 OF 4

10088-52

THIS DOCUMENT CONTAINS CONFIDENTIAL AND PROPRIETARY INFORMATION.
ALL RECIPIENTS OF THIS DOCUMENT ARE TO PROTECT THE OWNERS DATA FROM USE BY OR TRANSFER
TO NON AUTHORIZED PARTIES BY LEGAL MEANS POSSIBLE COPYRIGHT © 2013 CAD DESIGN AND DRAFTING

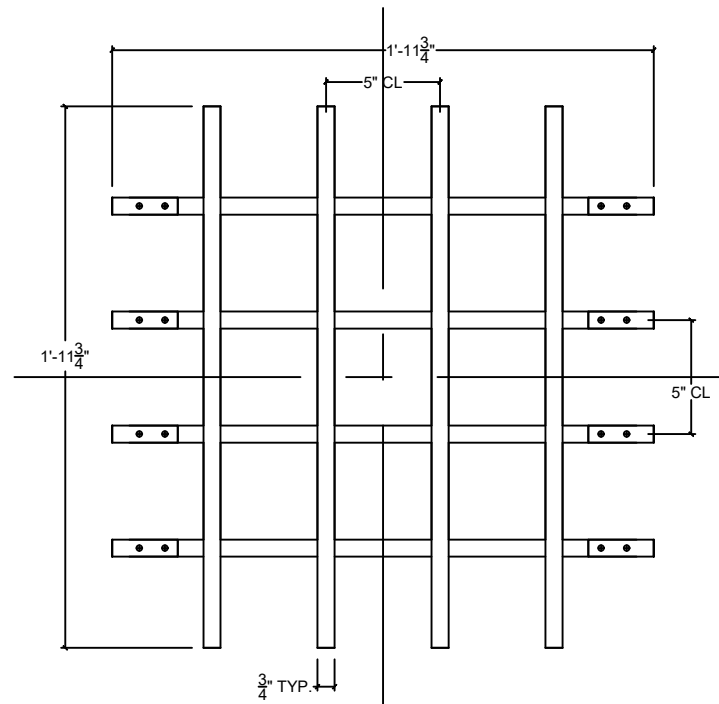

PLAN

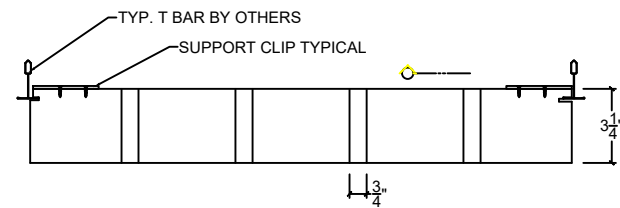

SECTION

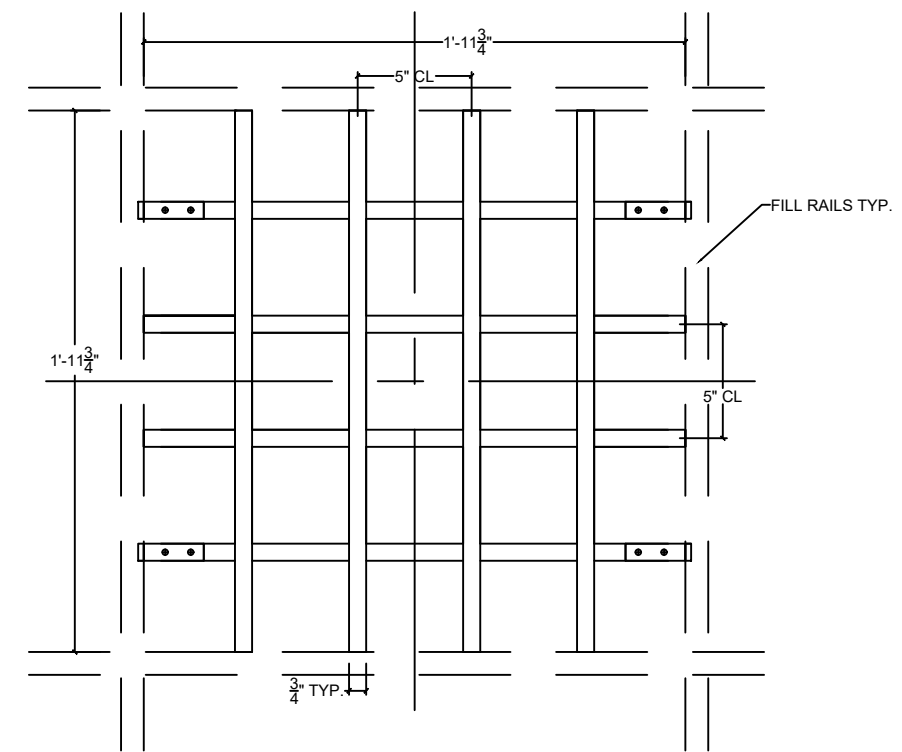
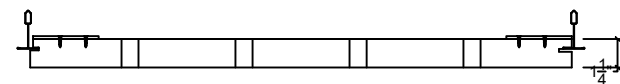
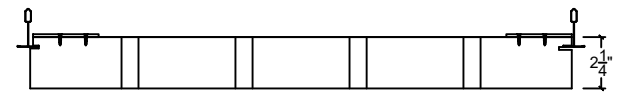

PLAN

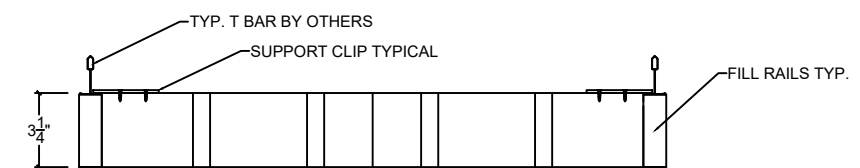

SECTION

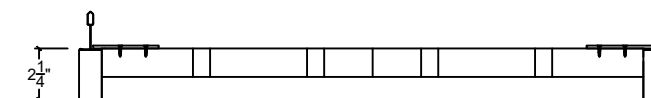
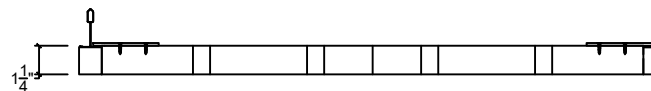

10088-53



MADRID

7800 INDUSTRY AVENUE
PICO RIVERA, CA 90660
WWW.MADRIDINC.COM

OPEN CELL

GRID LOCK 5"

3 OF 4

10088-55

THIS DOCUMENT CONTAINS CONFIDENTIAL AND PROPRIETARY INFORMATION.
ALL RECIPIENTS OF THIS DOCUMENT ARE TO PROTECT THE OWNERS DATA FROM USE BY OR TRANSFER
TO NON AUTHORIZED PARTIES BY LEGAL MEANS POSSIBLE COPYRIGHT © 2013 CAD DESIGN AND DRAFTING

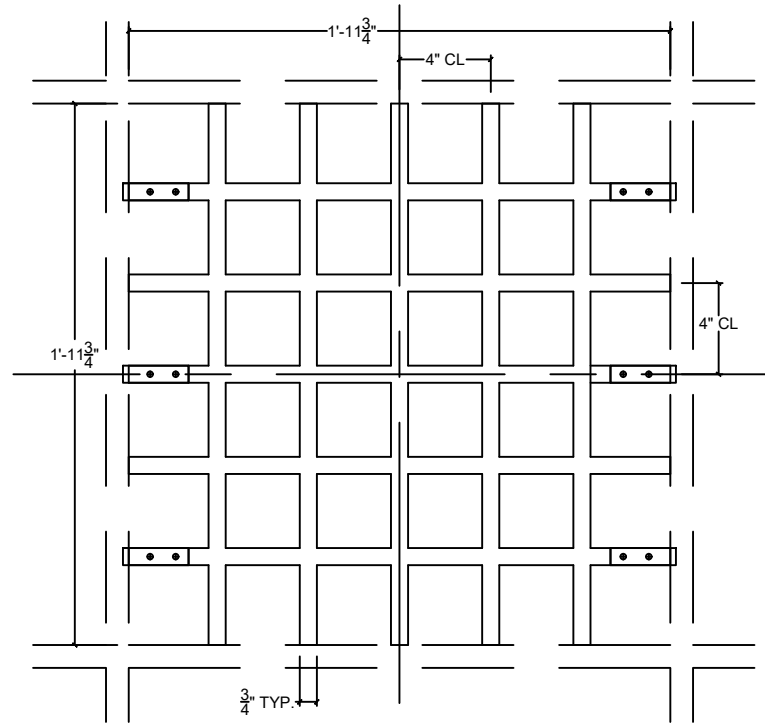

PLAN

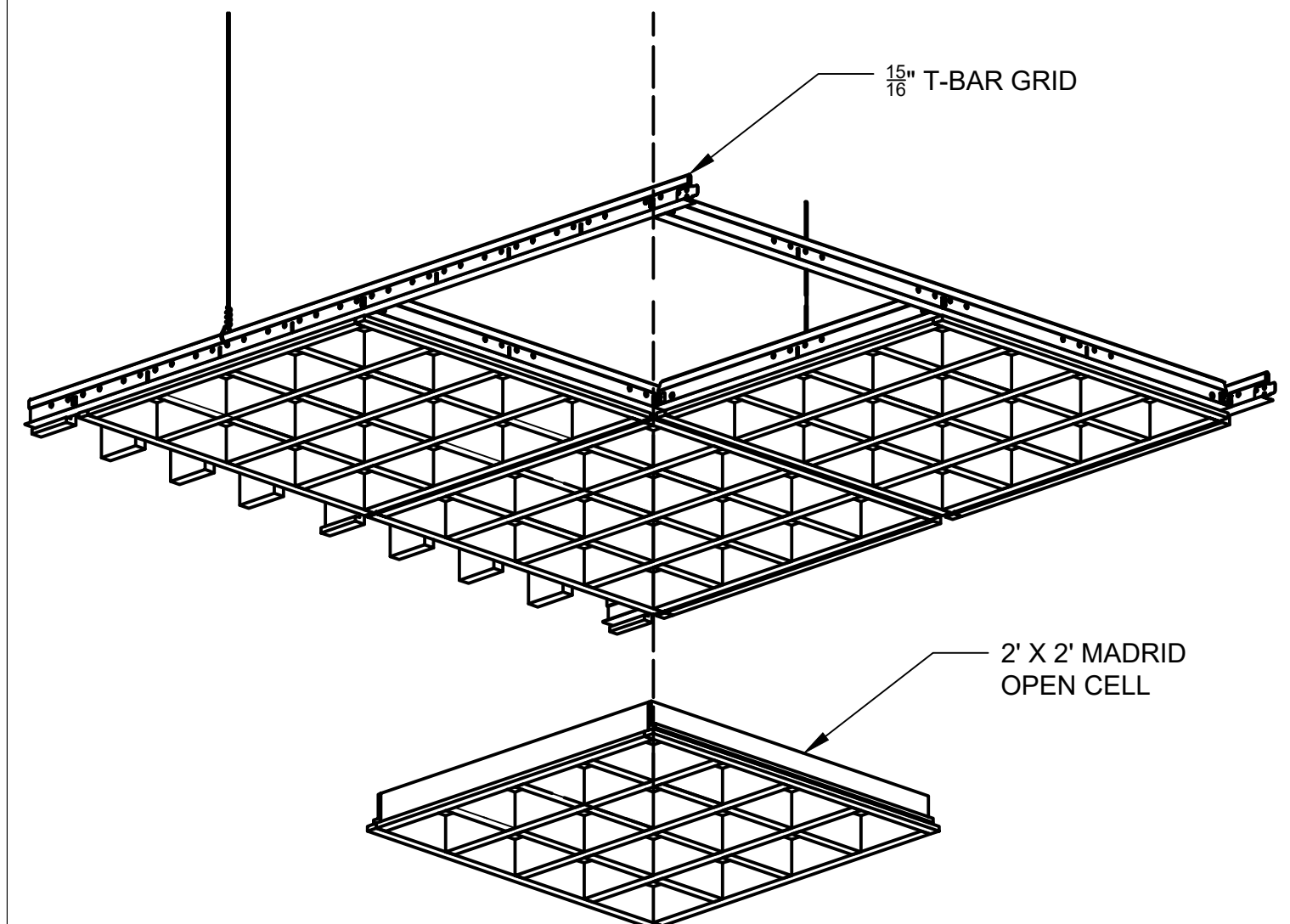

ISO VIEW

SECTION

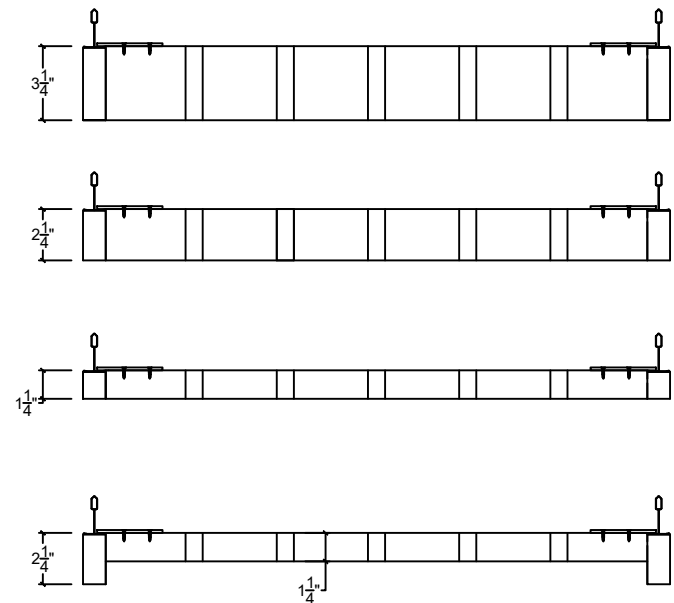

10088-57



MADRID

7800 INDUSTRY AVENUE
PICO RIVERA, CA 90660
WWW.MADRIDINC.COM

OPEN CELL

DROP IN 4"

4 OF 4

THIS DOCUMENT CONTAINS CONFIDENTIAL AND PROPRIETARY INFORMATION.
ALL RECIPIENTS OF THIS DOCUMENT ARE TO PROTECT THE OWNERS DATA FROM USE BY OR TRANSFER
TO NON AUTHORIZED PARTIES BY LEGAL MEANS POSSIBLE COPYRIGHT © 2013 CAD DESIGN AND DRAFTING